

Mark Bric®

A Family of Dependable Displays™

Sign & Poster Stands



Banner Stands



PopUp Displays



Backlit Displays



Frames & Banner Rails



Modular Displays & Exhibits



Literature Stands



Volume III
www.markbric.com

Suggested retail prices, ground freight included



Mark Bric® Multi Master

A Family of Dependable Displays

MultiMaster banner stand

page 1



Mark Bric® BANNER RAIL™

A Family of Dependable Displays

Banner Rail - Aluminum (Slide-in and Snap-lock)

page 2

Banner Rail - Plastic

page 2



Mark Bric® BANNERUP®

A Family of Dependable Displays

Mark Bric BannerUp Lite

page 3

Mark Bric BannerUp Original & Plus

page 4

Accessories

page 5

Banner production guidelines

page 23



Mark Bric® SNAPUP®

A Family of Dependable Displays

Mark Bric SnapUp Original

page 6

Mark Bric SnapUp-MP

page 7

Mark Bric SnapUp-MP Counter

page 8

Accessories

page 8

Panel production guidelines

page 23

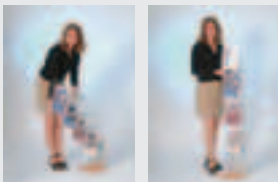

Mark Bric® STANDUP™

A Family of Dependable Displays

Mark Bric StandUp Lite, Plus and Original

page 9

Portable Literature Stands

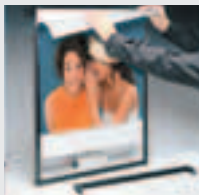

Mark Bric® LIGHTUP™

A Family of Dependable Displays

Single Light Boxes

page 10

Light Towers and Exhibits

page 11



Mark Bric® FLEXIFRAME®

A Family of Dependable Displays

Single frames

page 12

Floor stands

page 13

Floor & Table stand brackets / Swing wings

page 14

Exhibit kits and backwalls

page 15

Table, Tower and Cross units - LinkUp

page 16

Counters, tabletop displays, ceiling displays

page 17

Complete Trade Show stands - ShowUp

page 18

Accessories, componets, & dealer information

pages 19 -24



Introducing the newest member of our Family of Dependable Displays!

Banner Stands



One stand - Mastering Multiple Challenges!

- Features snap-lock BannerRail™ to secure the graphics
 - Works with virtually all banner materials
 - No grommets or pole pockets required
 - Single and double sided functionality
 - Telescopic pole for maximum flexibility
- One case holds everything - including the banner!
 - Banners up to 9½ ft. tall x 46 in. wide



Tall & thin.....wide & lifted up.....easily portable.....easily set up!

Model/Size	Price single-sided	Price double-sided	Description	Item #
18"	\$159.00	\$169.00	Aluminum stand with rails, 18" banner width	86150
20"	\$159.00	\$169.00	Aluminum stand with rails, 20" banner width	86151
22"	\$169.00	\$179.00	Aluminum stand with rails, 22" banner width	86152
24"	\$169.00	\$179.00	Aluminum stand with rails, 24" banner width	86153
36"	\$179.00	\$199.00	Aluminum stand with rails, 36" banner width	86154
40"	\$179.00	\$199.00	Aluminum stand with rails, 40" banner width	86155
46"	\$189.00	\$219.00	Aluminum stand with rails, 46" banner width	86156
Pole Set Only	\$149.00	\$149.00	Aluminum stand for rigid panels - no banner rails	86100
Custom Width	\$149.00 + \$1 per inch of banner width	\$149.00 + \$2 per inch of banner width	Aluminum stand with rails, custom banner width	



Multipurpose functionality

The basic MultiMaster pole set can also be used to present foam boards and other flat panel materials.

Specifications:

- Approx. weight – 8 lbs.
- Maximum floor clearance – 42"
- Widths up to 46"
- Banner thickness to 0.016" (16 mil)
- Heights up to 9½ ft.
- Case measures 6" d x 48" l

Full details on BannerRail are shown on the following page.

Rails for banner suspension



Aluminum Snap-lock design



Open & Load



Snap Shut

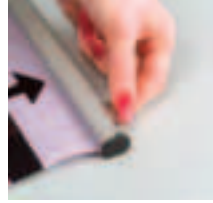

Snap Open

- Simple snap-lock design
- No plastic insert required
- Grips up to 0.16" (16pt) thickness
- Unbroken lengths up to 90"



Aluminum Slide-in design



Set Grommet



Load



Cap Ends

New Product!

- Simple slide-in design
- Perfect for heavy substrates such as poster board and PVC sheeting
- Grips up to 3/32" (93 pt) thickness
- Unbroken lengths up to 96"



Plastic Slide-in design



Fold & Staple



Load



Cap Ends

- Simple slide-in design
- Super low-cost solution
- Grips up to 1/16" (62 pt) thickness
- Unbroken lengths up to 90"

Standard Size	Packing	Plastic Slide-in		Aluminum Slide-in		Aluminum Snap-lock	
		Price	Item No.	Price	Item No.	Price	Item No.
18"	1 kit	\$5.20	84054	\$13.60	85105	\$16.30	85054
20"	1 kit	\$5.70	84055	\$15.00	85106	\$18.10	85055
22"	1 kit	\$6.30	84056	\$16.40	85107	\$19.80	85056
24"	1 kit	\$6.80	84057	\$17.80	85108	\$21.60	85057
36"	1 kit	\$10.30	84061	\$26.20	85112	\$32.60	85061
40"	1 kit	\$11.40	84062	\$29.00	85113	\$36.10	85062
48"	1 kit	\$13.80	84063	\$34.60	85114	\$43.40	85063
Custom Cuts	1 kit	\$0.40 per inch		\$0.80 per inch		\$1.00 per inch	

Note: All kits contain two rails with all caps, eyelets, and other accessories needed for use on top and bottom of banners.



Component parts	Packing	Price	Item No.	Price	Item No.	Price	Item No.
Full length	per length	\$7.50	84009	\$30.00	85100	\$37.00	85009
	per box	\$335.00/50 pcs.	84009	\$550.00/20 pcs.	85100	\$680.00/20 pcs.	85009
End Caps	each	\$0.25	84048	\$0.25	85191	\$0.25	85048
	per box/100	\$20.00	84048	\$20.00	85191	\$20.00	85048
Hanging Eyelets	each	\$0.25	85049	\$0.25	85049	\$0.25	85049
	per box/100	\$20.00	85049	\$20.00	85049	\$20.00	85049
Splicer	each	\$0.50	85192	\$0.50	85192	\$0.50	85192
	per box/100	\$40.00	85192	\$40.00	85192	\$40.00	85192
Grommets	each	\$0.80	85193	\$0.80	85193	\$0.80	85193
	per box/100	\$70.00	95193	\$70.00	95193	\$70.00	95193

Banner Stands

Mark Bric BannerUp[®] Lite

- Lightweight, low cost and user friendly
- Adjustable height, custom widths
- Single and double-sided options
- Quick & easy banner change



The sleek, slim lines of the Mark Bric BannerUp Lite enhance the banner.

Specifications:

- Standard Width - 3ft. (34 $\frac{5}{8}$ "
- Width Range- 1 $\frac{1}{2}$ ft. to 5 ft.
- Full height range - 5 to 7 ft. single- sided, 5 $\frac{1}{2}$ - 7 $\frac{1}{2}$ ft. double-sided
- Banner materials - unlimited
- Approximate weight - 4 lbs.
- Includes simple drawstring storage bag

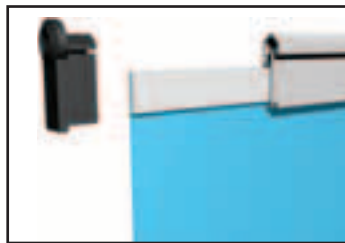

Quick-change strips mean no grommets or sewn pockets.

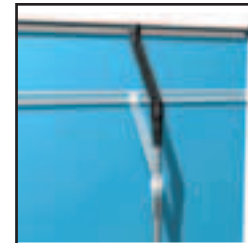

Telescoping pole allows custom banner heights.



Single-sided



Double-sided



Custom widths available



The optional nylon carry cases accommodate banners up to 60" wide, with enough room for two single sided units or one double sided unit, along with a 3" diameter graphic storage tube.



Model	Price	Description/Color	Item #
3 ft. Single-Sided	\$129.00	Aluminum anodized, black plastic	86010
3 ft. Double-Sided	\$179.00	Aluminum anodized, black plastic	86020
3 ft. Quick-Change kit	\$10.00/pair	White PVC strip with adhesive	86055
3 ft. Graphics tube	\$5.00	3" dia. white fiber tube with caps	86060
Standard carry case	\$35.00	46", Black nylon with handles	5050
Jumbo carry case	\$55.00	60", Black nylon with handles	5051
Custom width, single-sided	\$100.00 + \$1/inch banner width	Aluminum anodized, black plastic	86040
Custom width, double-sided	\$100.00 + \$2/inch banner width	Aluminum anodized, black plastic	86041
Multi-unit connector	\$20.00	Chromed steel, connects 3 banner stands in-line	86053
Extra mounting rails	\$0.50/linear inch	Aluminum anodized	86043
Extra quick-change strips	\$0.15/ linear inch	White PVC strip with adhesive	86044

Retractable Banner Stands

Now Recognized Worldwide!

Join the thousands of satisfied users in more than 60 countries around the world that have made the Mark Bric BannerUp their favorite banner stand!



\$399
Reduced pricing on our popular 3 ft. models

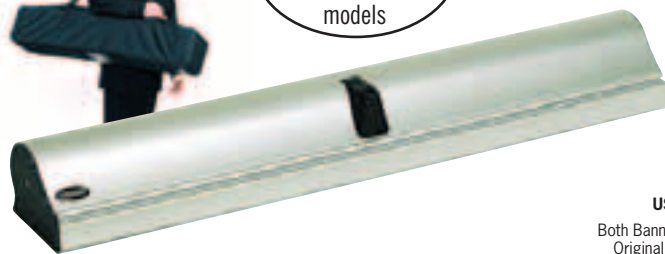

\$299

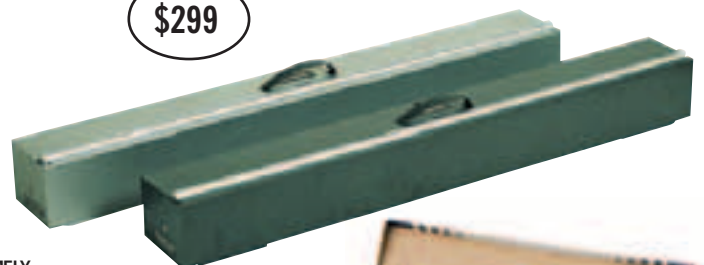

EXTREMELY USER-FRIENDLY!!
Both BannerUp Plus and BannerUp Original are equipped with our unique banner change – see next page!!!



Mark Bric BannerUp[®] Plus (Taller, lighter, more print area!)

- Top-of-the-line 'quick-change' banner stand
- Slim-line design enhances banner graphics
- Lightweight aluminum construction for portability
- Hideaway swivel feet for extra stability
- Adjustable tension for different banner materials
- Deluxe carrying case is included

Mark Bric BannerUp[®] Original

- Original 'quick change' retractable design
- Rugged steel construction
- Perfect for tough environments
- Durable powder-coat finish (gray or anthracite)
- Hideaway swivel feet for extra stability
- Adjustable tension for different banner materials

Mark Bric BannerUp Plus including luxur carrying bag

All prices are exclusive of banner. Includes 1 pair of "Quick-change" banner rails (top and bottom).

Model/Width	Price Each	Color	Item No.
3 ft.	\$399	Aluminum anodized	81115
40 in.	\$499	Aluminum anodized	81116
4 ft.	\$569	Aluminum anodized	81117
5ft.	\$699	Aluminum anodized	81118

Mark Bric BannerUp Original including transport box

All prices are exclusive of banner. Includes 1 pair of "Quick-change" banner rails (top and bottom).

Model/Width	Price each	Color	Item No.
3 ft.	\$299	Anthracite (91)/Silver gray (98)	81010
40 in.	\$369	Anthracite (91)/Silver gray (98)	81011
4 ft.	\$419	Anthracite (91)/Silver gray (98)	81012
5ft.	\$499	Anthracite (91)/Silver gray (98)	81013

"Quick-Change" Mounting Kit



EASY BANNER CHANGE

An invention by Mark Bric enables you to repeatedly use different banners in the same cassette. Just slide the old banner out of the cassette and replace it with a new one in just minutes. Fast and Simple!

U.S. patent appl. no. 10/396,076 Eur patent no. 1285421

One quick-change mounting kit is included with each BannerUp unit, enabling the first banner to be installed. Subsequent banners can be easily installed with the aid of a new quick-change kit, including top and bottom rails ready for mounting.

Model/Width	Price each	Item No.
3 ft.	\$40.00	81020
40 in.	\$45.00	81030
4 ft.	\$55.00	81040
5ft.	\$70.00	81050

(Quick-change kits are interchangeable for BannerUp Original & BannerUp Plus)

Accessories

For Mark Bric BannerUp Plus and Original



Foam end-caps for extra protection. To be kept in the bag at all times.

Padded carrying bag with shoulder strap.
(Bag is included with every BannerUp Plus)

Model/Width	Price Each	Item No.
3 ft.	\$79.00	5020
40 in.	\$89.00	5021
4 ft.	\$99.00	5022
5ft.	\$159.00	5023



Focus attention on your BannerUp with a halogen spotlight.

Halogen spotlight 120V/50W. *(includes spare bulb)*

Price Each	Item No.
\$89.00	81005

Extension poles - custom lengths

For increased height of banner. For 3ft/40in use 1 pc. For 4ft/5ft use 2 pcs.

Price	Item No.
\$2 per inch	89255

Whether individually or in combination, Mark Bric BannerUp® is at home in any venue!

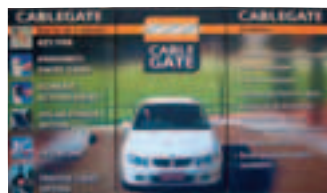

SnapUp Models

Dependable Pop-Up Display Systems from Mark Bric!

- Compact, portable & user friendly
- A full range of product choices
- Great for both fabric and full-mural graphic panels

Mark Bric SnapUp[®]-Original

Key Features

- Perfect for fabric panels (included in all kits)
- Square-tube, open-frame aluminum construction
- Curved, straight and tabletop models available
- One-piece channel bar construction
- Complete 10' ft. Show Kit for only **\$2,699**



Complete Show Kit (plus optional shelf)

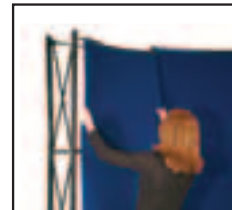
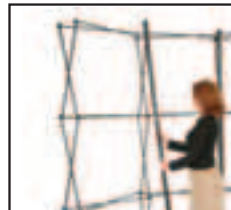
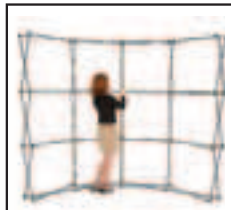
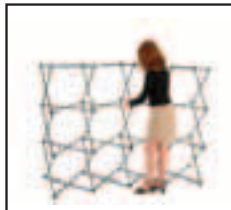

SnapUp-Original Models

Each SnapUp-Original backwall and tabletop includes:

- The modular square-tube frame structure in one of our standard sizes
- A complete set of channel bars for attaching fabric or graphic panels
- Traditional hard shell shipping case
- A complete set of Front Runner-brand fabric panels in your choice of color
- **Showkits** also include two 200W halogen spotlights and a case-to-counter conversion kit

*Stock fabric colors are blue, gray and black. Others available by request.

All prices include fabric panels

Floor Models



\$2,199

10 ft. curved (4 x 3 quad)
120" w x 92" h x 38" d
Std. Kit, \$2199 #82000
Showkit, \$2699 #82100



\$2,199

10 ft. straight (3 x 3 quad)
114" w x 92" h x 17" d
Std. Kit, \$2199 #82001
Showkit, \$2699 #82101



\$1,999

8 ft. curved (3 x 3 quad)
94" w x 92" h x 28" d
Std. Kit, \$1999 #82010
Showkit, \$2499 #82110

Table-Top Models



\$1,499

8 ft. curved (3 x 2 quad)
94" w x 62" h x 28" d
\$1499 #82012



\$1,399

7 ft. straight (2 x 2 quad)
84" w x 62" h x 17" d
\$1399 #82021



\$1,299

6 ft. curved (2 x 2 quad)
72" w x 62" h x 22" d
\$1299 #82020

Mark Bric SnapUp®-MP

Key Features

- Perfect for full-mural digital graphics (*graphic panels not included*)
- Round-tube, fully cross-braced and magnetically locked aluminum construction
- Three standard curved floor models and two cylindrical towers available
- Three-piece channel bars snap into position magnetically
- Complete 10' ft. Show Kit for only **\$2,099**

Fabric Options!

- Add Front Runner-brand fabric endcaps - **\$225** per set
 - Add fabric case wrap - **\$175** each
- Stock fabric colors are blue, gray and black.



Complete Show Kit (panels not included)

The case can be easily converted into a counter, with wrap-around graphics.



Backwall Kit

Every SnapUp-MP Backwall Kit includes:

- The new Magnet Pro cross-braced, multi-lock frame structure in one of our standard sizes.
- Kick plates and hook plates for graphic panels.
- A complete set of channel bars for attaching the graphics.
- Magnetic tape for mounting graphics to channel bars
- **Showkits** also include two 200W halogen spotlights and our deluxe multi-compartment shipping case (5040) with a case-to-counter conversion kit.



Showkit (panels not included)

SnapUp-MP Backwalls

All prices are exclusive of graphic panels



\$1,599

10 ft. curved (4x3 quad)
113" w x 89" h x 33" d
Std. Kit, **\$1599** #7860
Show Kit, **\$2099** #7805



\$1,399

8 ft. curved (3x3 quad)
91" w x 89" h x 24" d
Std. Kit, **\$1399** #7861
Show Kit, **\$1899** #7806



\$1,199

6 ft. curved (2x3 quad)
67" w x 89" h x 16" d
Std. Kit, **\$1199** #7862
Show Kit, **\$1699** #7850

SnapUp-MP Towers

All prices are exclusive of graphic panels

Every SnapUp MP tower kit includes:

- The new Magnet Pro frame structure
- A complete set of channel bars for attaching the graphics
- Kick plates & hook plates for graphic panels
- Magnetic tape for mounting graphics to channel bars



7 ft. tower (3x3 quad)
88" h x 26" d
\$699
#7864



Extra high!
Nearly 10 ft. tall
10 ft. tower (3x4 quad)
116" h x 26" d
\$879
#7865



Easy set up!

Backlit for greater impact!

Attract even more attention with our new Tower Light Kit! Create a column of almost 10,000 lumens of cool-white florescent light directly in the center of the tower, exactly where you need it for dynamic backlit graphics.

This portable light kit uses 3 hinged pairs of 20 watt T4 lamps, requiring only one 120 VAC power connection. The tower, light kit and graphics all fit conveniently inside our hard case #82008 (*next page*).

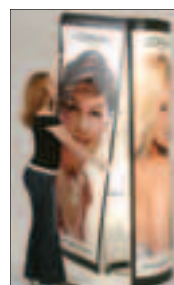
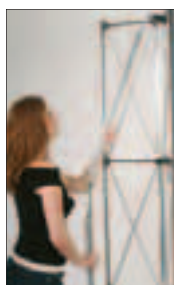

Reduced Pricing

7' Tower
Light Kit
\$599
#80010

SnapUp - MP counter

New Product!



Introducing the totally new SnapUp®-MP counter!

A functional, decorative counter that works like a pop-up system.

- Sets up in 5 mins.
- Classy wooden top and shelves
- Use with fabric or graphic panels
- Includes canvas carrying bag
- Weighs less than 25 lbs.
- Showkit model includes the rugged Luxus hard shell shipping case and fabric wrap in black, gray or blue



Model	Price	Description	Item No.
MP Counter	\$799.00	Hardware, soft case & mag. tape	82038
Fabric wrap kit	\$99.00	3 panels - black, gray or blue	9840
Luxus transport case	\$199.00	High impact plastic shipping case	5080
Showkit	\$999.00	Counter, fabric wrap & Luxus case	7863



Luxus transport case

Accessories: SnapUp - MP

Hard case on wheels

Our multiple-use hard transport case can easily be converted into a counter with wrap-around graphics. It has three well-protected compartments: One for the structure, one for the graphic panels and one (the lid) for 2 spotlights. The lid may also be used as a step when assembling the spotlights on the system. A wooden counter top in black/beechn is included. The case is equipped with heavy-duty, easy-roll rubber wheels.



\$495, #5040

Multi-compartment case provides extra graphics protection and makes loading and unloading lighter and easier.

Soft Cases for SnapUp



Item 5046

Item 5045

Padded carrying bag for graphic panels, with shoulder strap.
\$120, #5046

Padded carrying bag for the structure, with shoulder strap.
\$120, #5045



Wall-Washer Halogen Spotlight with easy fit connector (standard with all Showkits) Provides maximum light output, but restricted in a very few convention centers. Please check with your convention center to be sure. 200W, 120VAC.
\$160, #80006



Par 30 Halogen Spotlight with easy-fit connector. Fully enclosed halogen lamp meets even the tightest known convention center regulations. 75 W/120VAC.
\$160, #80008

Accessories: SnapUp - Original

Oval Case on Wheels

Sturdy, hard-shell case with heavy-duty wheels provides a safe, effective way to store & transport your complete SnapUp kit. Case converts easily to a counter, with optional fabric-wrap panels and decorative drop-in countertop lid.

Square Case on Wheels

This heavy-duty case is standard with all table-top models. Two of these cases provide an alternative means of transporting floor model SnapUps. Ask Customer Service for full details.



Oval Case
(for floor models)
\$420, #82009



Square Case
(for tabletops and towers)
\$375, #82008

Other accessories include:	Price	Item No.
Halogen Spotlight, 200W, 120VAC	\$160	82051
Product/brochure shelf	\$135	82060
Podium kit, converts case to counter	\$250	82070

Portable Literature Stands

- Just fold them up and take with you!
- 3 styles and price points to suit all applications
- Each unit comes with its own carrying case
- Perfect for tradeshow, lobbies, and all portable presentation needs



Scissor-type set up on the Plus and Original keeps literature on the shelves, ready to display!

New Product!

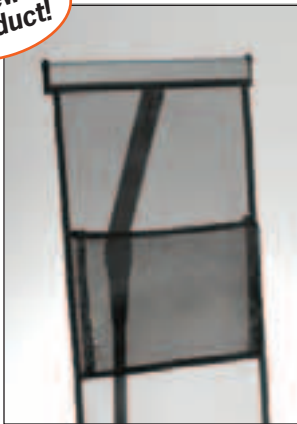

StandUp Lite

\$129, # 83002 single
\$169, #83003 (double)

- 4 (or 8) pockets - 8½"x11"
- 50 sheets per pocket
- Rollup fabric, telescoping alum. pole
 - Black mesh, silver aluminum
- 12"w x 13"(or 16")d x 56"h on display
 - 4" x 4" x 38" for transport
 - 4 lbs. including case

New Product!

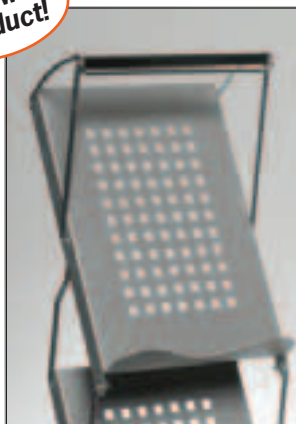

StandUp Plus

\$349, # 83020

- 5 shelves - 8½"x11"
- 100 sheets per shelf
- Folding, all steel construction
 - Matte black or silver gray
- 10"w x 22"d x 61"h on display
- 10" x 10" x 14" for transport
- 15 lbs. including deluxe case



StandUp Original

\$429, # 83000

- 4 shelves - 8½"x11"
- 100 sheets per shelf
- Folding, acrylic pockets, alum. frame
 - Silver gray
- 10"w x 12"d x 62"h on display
- 10" x 12" x 18" for transport
- 11 lbs. including case

Light-Up DisplaysTM



- High-impact backlit displays
- Modular & interlocking for maximum creative freedom
- Ultra Thin profile fits in everywhere
- Perfect for walls, ceilings, counter-tops, & floorstands
- Easy graphics change



Our patented Flexiframe frames and interlocking hardware allow for tool-free connections.

ultra thin profile..... lightweight..... lens & diffuser included also used with stands.



Single Light Boxes

- Ultra Thin design is only 3 " thick
- UL listed for safety & dependability
- Standard sizes for ease of use
- Easy graphics change
- Easy to accessorize & interconnect
- Standard, easily replaced bulbs
- Lightweight for easy mounting & transport



Converts easily to tabletop display

Size	Price	Item
16" x 20"	\$249	8053
20" x 24"	\$259	8054
22" x 28"	\$329	8055
24" x 30"	\$349	8056
24" x 36"	\$389	8057
32" x 40"	\$549	8058
40" x 50"	\$599	8059
16" x 40"	\$349	8060
16" x 50"	\$399	8061
70 x 100cm (27 ⁹ / ₁₆ X 39 ³ / ₈)	\$549	8062 *

* 8062 is built with UL listed components, but is not a UL listed fixture.

- Creative backlit display systems attract lots of attention
- Connect single LightUps to form dynamic exhibits
- Mix and match framed graphics & backlit panels
- Modular design allows for easy reconfiguration



Model	Price	Light Panel Size	Landscape Layout Size	Portrait Layout Size	Item No.	
Light Column	\$1,799	16 x 20" (2) 16 x 50" (2)	17 x 17 x 81"h	n/a	8081	
Light Walls	<i>Single Side</i>	\$2,999	24 x 30" (4)	64 x 19 x 68"h	52 x 19 x 80"h	8082
	<i>Single Side</i>	\$3,999	32 x 40" (4)	84 x 19 x 84"h	68 x 19 x 100"h	8083
	<i>Single Side</i>	\$4,699	40 x 50" (4)	104 x 19 x 100"h	84 x 19 x 120"h	8084
	<i>Double Side</i>	\$4,299	24 x 30" (8)	64 x 19 x 68"h	52 x 19 x 80"h	8085
	<i>Double Side</i>	\$5,799	32 x 40" (8)	84 x 19 x 84"h	68 x 19 x 100"h	8086
	<i>Double Side</i>	\$6,499	40 x 50" (8)	104 x 19 x 100"h	84 x 19 x 120"h	8087
Square Kiosks		\$3,299	24 x 30" (8)	42 x 42 x 68"h	36 x 36 x 80"h	8088
		\$4,699	32 x 40" (8)	52 x 52 x 84"h	44 x 44 x 100"h	8089
		\$5,299	40 x 50" (8)	62 x 62 x 100"h	52 x 52 x 120"h	8090
Triangular Kiosks		\$3,499	24 x 30" (6)	42 x 42 x 68"h	36 x 36 x 80"h	8091
		\$4,499	30 x 40" (6)	52 x 52 x 84"h	44 x 44 x 100"h	8092
		\$4,999	40 x 50" (6)	62 x 62 x 100"h	52 x 52 x 120"h	8093
Hexagonal Kiosks		\$5,299	24 x 30" (9)	52 x 52 x 93"h	64 x 64 x 111"h	8094
		\$7,199	32 x 40" (9)	84 x 84 x 117"h	67 x 67 x 141"h	8095
		\$8,499	40 x 50" (9)	104 x 104 x 141"h	84 x 84 x 171"h	8096
X-Shaped Kiosks		\$8,499	24 x 30" (16)	83 x 83 x 68"h	71 x 71 x 80"h	8097
		\$11,499	30 x 40" (16)	103 x 103 x 84"h	87 x 87 x 100"h	8098
		\$12,899	40 x 50" (16)	123 x 123 x 100"h	103 x 103 x 120"h	8099

Prices include all components - light boxes (quantity indicated in parenthesis), blank panels and connectors - padded and packed in corrugated shipping boxes. Specially designed wooden shipping crates are available by special order - call for details.

Light Tower Exhibit Systems

- Complete customized LightUp exhibit systems
- Unique exhibit designs stand out in a crowded marketplace
- Affordable, portable, no-tool assembly
- Unlimited configuration options--call for more details!

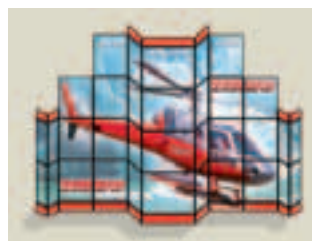
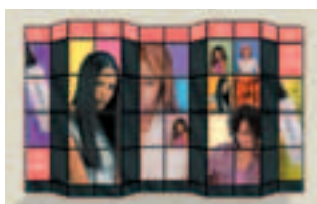

Single Frames

All prices are exclusive of insert panels



The **standard** frames are delivered with **top opening** on the short side for portrait style. If you prefer a different opening, or a fully closed frame, please specify when ordering.

For panels up to .220 in (5½ mm) thickness

1 pc. packing: All components for one frame packed together in a plastic bag.

Bulk packing: Unassembled components for 10 frames are packed in a box. One color and one size.

Standard Size	1 pc. Packing	Bulk (10+ frames)	Item no.
8½ x 11"	\$12.40	\$11.20	150
11 x 14"	\$16.00	\$14.40	151
11 x 17"	\$17.30	\$15.60	164
14 x 22"	\$22.50	\$20.30	152
16 x 20"	\$22.50	\$20.30	153
18 x 24"	\$25.90	\$23.30	154
20 x 24"	\$27.40	\$24.70	155
22 x 28"	\$31.20	\$28.10	156
24 x 36"	\$37.50	\$33.80	157
28 x 40"	\$42.40	\$38.20	158
30 x 40"	\$43.70	\$39.30	159
*Basic 70 x 100cm	\$42.50	\$38.30	101
*Mini 50 x 70cm	\$28.80	\$25.90	103
*Basic Header 70 x 30cm	\$23.70	\$21.30	105
*Mini Header 50 x 20cm	\$17.20	\$15.50	107

Corners

Single frames are delivered with rounded corners as standard. Square corners are delivered on request.

All frames now include corner locks. The corner locks will prevent the corners from sliding out of the profile. The locks may be easily removed by the user, if desired.

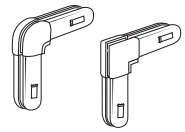

Sizes

All sizes are insert panel size.
Outer frame size = panel size plus 1½"
Visible panel size = panel size minus ¾"
Panel thickness up to .220" (5½ mm)

Basic and Mini-Basic are the standard frames used in our backwalls, tables, towers, etc. They are based on common international metric sizes, which convert to the following English measurements:

Basic: 27¼" x 39¼"
Basic Header: 27¼" x 11¼"
Mini Basic: 19¼" x 27¼"
Mini Basic Header: 19¼" x 7"

There are 14 standard colors to choose from, enabling you to match your graphic panel and/or your company identity.



SPECIAL SHAPES / SPECIAL COLORS

Custom Sizes & Shapes

FLEXIFRAME can be ordered in your custom sizes and shapes. Prices: 1 Piece Packing \$0.35 / linear inch and Bulk Packing \$0.31 / linear inch. For triangles add \$5.00 per frame, for hexagons add \$10.00.

Arrow frames

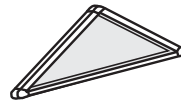

Special frame colors

PMS matching.
Min. quantity: 1500 ft
Standard price +10%

MOUNTING AND SUSPENSION OF SINGLE FRAMES

<p>2000</p> <p>Wall bracket Quick mounting \$1.30 / pair</p>	<p>2001</p> <p>Wall bracket Fixed mounting \$2.60 / pair</p>	<p>2002</p> <p>Wall hook \$9.50 / pair</p>	<p>2010</p> <p>Spring hook \$22.00 / pair Max. frame size 22 X 28"</p>	<p>2005</p> <p>C-hooks \$1.30 / pair</p>	<p>2006</p> <p>Chain \$0.55 / ft</p>	<p>2007</p> <p>Window suction mount \$3.50 / pair</p>
<p>2003</p> <p>Slatwall Bracket \$2.75 / pair</p>	<p>2004</p> <p>Grid clip For suspended ceiling mount. \$1.20 / pair</p>	<p>2110 - 2111</p> <p>Uni-clamp Use with a stem (2100 - 2106) 2110 — 1 - 1½" 2111 — 1½ - 2½" \$8.25/each</p>	<p>2112</p> <p>Uni-clamp Use with a stem (2100 - 2106) Opening ½ - 1½" \$8.25/each</p>	<p>2100</p> <p>Stem for clamp Adjustable height 10" - 18" \$11.00/each</p>	<p>2101 - 2106</p> <p>Stem for clamp Fixed height 2106 1½" \$5.00 2101 4" \$5.50 2102 8" \$6.00 2103 12" \$6.50 2104 16" \$7.00</p>	<p>80901 - 80902</p> <p>Mounting tape Magnetic / Hook & Loop \$2.50 / foot</p>

2426

Max. frame size 11" x 17"

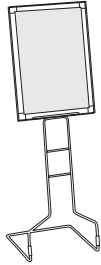

Mini-Stand

Height excluding frame 22", chrome plated (00). Can be equipped with brochure pocket (5100). Includes frame of your choice.

\$65.00

2415

Max. frame size 16" x 20"

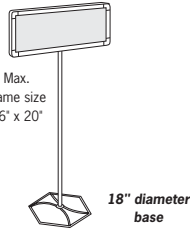

Flexi-Stand

Chrome plated (00). Height excl. frame 43". *Ideal to use with "arrow frames"*. Includes frame of your choice.

\$80.00

2400 2401

Fully Adjustable



Universal Floorstand

Chrome plated (00) Adj. Height excl. frame 25" - 45". For frames width 15" - 26" or 22" - 30". Includes frame of your choice.

\$99.00

2402

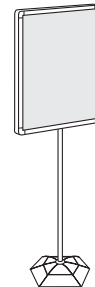

Web Base Floorstand

Includes frame 22" x 28" Chrome plated (00) Height incl. frame 66"

\$99.00

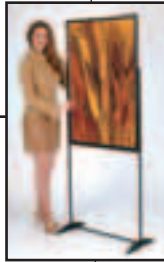

2404

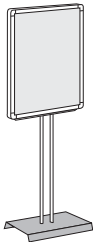

Prestige Floorstand

Includes frame 22" x 28" Stand Available in 3 colors: Black (93), gray (98), anthracite (91). Height incl. frame 66"

\$99.00
\$107.50 (w/ chrome posts)

2410

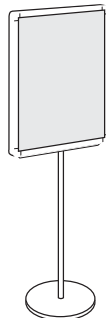

Dura-Stand

Includes frame 22 x 28 Stand available in 2 colors: Black (93) or anthracite (91). Height incl. frame 64"

\$135.00
\$145.00 (w/chrome posts)

2411

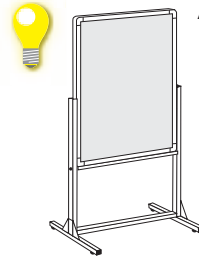

Many Accessories Available

Basic Floorstand

Includes frame 27⁷/₁₆ x 39³/₁₆. Stand available in 3 colors: White (92), gray (98) or anthracite (91). Height incl. frame 70".

\$150.00

2416

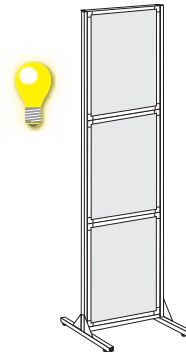

High-riser Stand

Includes 3 22" x 28" frames. Stand available in 3 colors: Black (93), gray (98) or anthracite (91). Height incl. frames 88"

\$190.00

2417

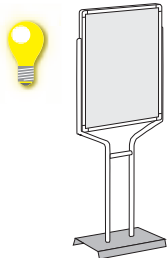

Decorator Stand

Includes frame 24" x 36" or 30" x 40". Stand available in 3 colors: Black (93), gray(98) or anthracite (91). Height incl. frame 70/74".

\$175.00

2422

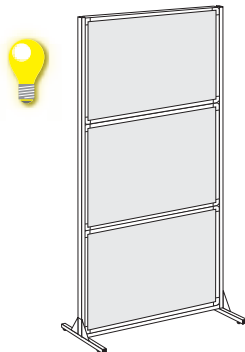

Basic High-riser Stand

Includes 3 frames 39³/₁₆ x 27⁷/₁₆. Stand available in 3 colors: Black (93), gray (98) or anthracite (91). Height incl. frame 88"

\$195.00

2435

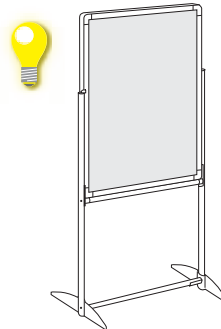

Soft Line

Available in 2 colors, black (93) and gray (98). Includes frame 22" x 28", 24" x 36" or 30" x 40". Height incl. frame 58/67/71".

\$145.00

2436

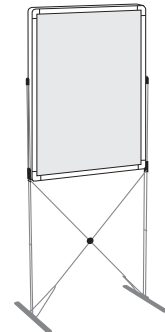

Adjustable from 11 x 17" up to 27⁷/₁₆ x 39³/₁₆"

X-Stand

Available in 2 colors, black (93) and gray (98). Includes frame of your choice. Height excl. frame 55".

\$145.00

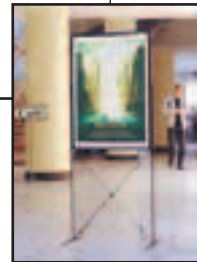

See color samples in back of catalog.

These stands now accept our LightUp backlit displays!

Accessories for Floor Stands

5100



Brochure pocket
8½"x11"
White (92), gray (98),
anthracite (91)
Fits all floor stands.

\$18.00

5103

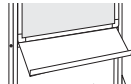

Brochure shelf
Width 70 cm. (27½")
White (92), gray (98),
anthracite (91)
Fits 2411

\$65.00

5105

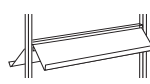

Brochure shelf
Double sided.
Width 70 cm. (27½")
White (92), gray (98),
anthracite (91)
Fits 2411

\$145.00/pair

5104

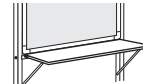

Product shelf
Width 70 cm. (27½")
Depth 27 cm. (10½")
White (92), gray (98),
anthracite (91)
Fits 2411.

\$65.00

3406



Wheels with lock
Fits 2411, 2416, 2422.

\$24.00/4pcs.

Floor Stand Brackets

All prices are exclusive of frames and insert panels

2300

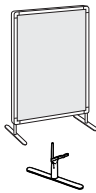

Straight Base
Height 4"
Chrome plated (00).
For any frame size.

\$30.00/pair

2301

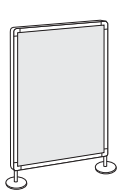

Round Base
Height 4"
Chrome plated (00).
For any frame size.

\$35.00/pair

2303

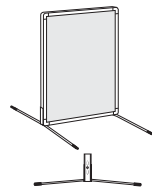

Stabilizing Feet
Chrome plated (00).
For any frame size.

\$18.00/pair

2305

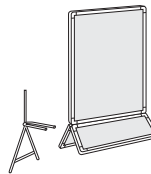

3-Frame bracket
Chrome plated (00).
For any frame size.

\$21.00/pair

2306

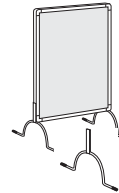

Arched feet
Height 5½".
Chrome plated (00).
For any frame size.

\$21.00/pair

2307



A-Stand brackets
Incl. 2 hinges, chrome (00),
black (93), and 4 Hfeet.
For any frame size.

\$25.00/pair

5899



Header brackets
For 2307
Chrome (00), black (93).

\$5.00/pair

Table Stand Brackets

All prices are exclusive of frames and insert panels

2205

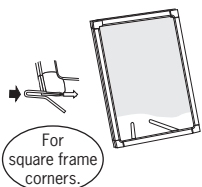

For square frame corners.

Tablestand bracket
Chrome plated (00).
Frames above 8½"x11"
use two brackets.

\$3.50 each

2200

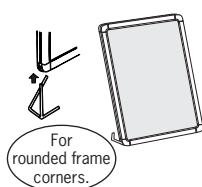

For rounded frame corners.

Tablestand bracket
Chrome plated (00).
Frames above 8½"x11"
use two brackets.

\$5.00 each

2203

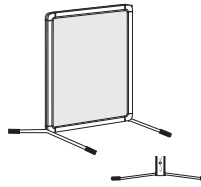

Short Stabilizing Feet
Chrome plated (00).
Frames up to 11"x17".

\$12.00/pair

2204



Hex Base stand
Chrome plated (00).
Frames up to 11"x17"
Fixed height 8"

\$12.00 each

2100 - 2106

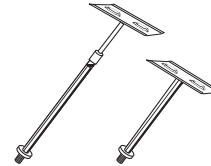

Elevating stems & bases

Chrome plated (00).
Max. frame size 8½"x11"

2100	10'-18"	\$11.00
2101	4"	\$5.50
2102	8"	\$6.00
2103	12"	\$6.50
2104	16"	\$7.00
2106	1½"	\$5.00

2120 2121

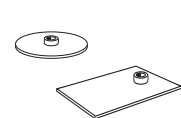

Chrome plated (00).

2120 Round Base	\$10.00 each
2121 Shovel Base	\$10.00 each

Swing Wing Units

All prices are exclusive of frames and insert panels

2013 2014

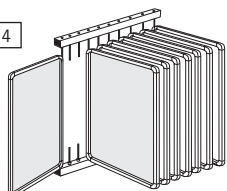

Swing wings, wall-mounted.

Metal holder available in 3 colors: Gray (98), White (92) and anthracite (91).
Can be used with any frame size up to 24"x36" in portrait format.

2013 (For max. 5 frames) \$50.00
2014 (For max. 10 frames) \$70.00



2420 2421

Floorstand with swing wings

Color: Anthracite (91). Can be used with frame heights of 8½, 11, 14, 18, 22, 24, 28, 30, 36 or 40 inches and can be equipped with a Mini Header frame 50 x 20 cm.

2421 - Single feet (For max. 10 frames) \$185.00
2420 - Double feet (For max. 20 frames) \$225.00

Flexiframe Exhibit Kits

Two Basic Backwall Models Available



Flexiframe LinkUp

The original backwall model based on the principle of individual frames that are easily joined together with metal connectors. LinkUp is particularly suitable for more stationary exhibits, which may have to be changed or added to at a later stage.

The frame sections are assembled and the backwall is delivered in a specially designed shipping carton.



Flexiframe FoldUp

These frame sections are joined together with fixed hinges that make set-up extremely quick and easy. FoldUp should be chosen when fast set-up and take-down are first priority.

Especially suited for tabletop displays and smaller backwalls. The complete backwall is assembled and delivered in a specially designed shipping carton.

Complete Exhibition Kits

\$1,050
Base price

Add a LightUp Display!
Call for details.

Classic 8: 115"(w) x 94"(h)
Classic 10, not shown: 144" (w) x 94"(h)

CLASSIC exhibition kit:

- 1 Basic 8 backwall with frames 70x100 cm (6003)
- 4 headers 70x30 cm (6008)
- 1 carrying case for frames (5001)
- 1 accessory bag (5006)
- 4 halogen spotlights, bulb 50W (81005)
- 2 brochure pockets (5100)

	w/o panels	w/ white foam board	w/ single side fabric
Classic 8 LinkUp 7003	\$1,050	\$1,214	\$1,626
Classic 10 LinkUp 7004	\$1,210	\$1,415	\$1,930

\$1,270
Base price

Add a LightUp Display!
Call for details.

Luxus 8: 115"(w) x 94"(h)
Luxus 10, not shown: 144"(w) x 94"(h)

LUXUS exhibition kit:

- Complete kit containing all of the same components as the Classic kit, upgraded to include one hard-shell shipping case on wheels, 9065.

	w/o panels	w/ white foam board	w/ single side fabric
Luxus 8 LinkUp 7013	\$1,270	\$1,434	\$1,846
Luxus 10 LinkUp 7014	\$1,420	\$1,625	\$2,140

Basic Backwall Units - with frame sections 70x100 cm (27 9/16" x 39 3/8")

Unless otherwise requested, closed frames are used in all backwalls for maximum stability. Frames for LinkUp systems have round corners; FoldUp frames have square corners.

	Image	Description	Total Size (w x h)	LinkUp			FoldUp			Item No.
				Price w/o Panels	Price w/ White foam-board	Price w/ Single-Side fabric	Price w/o Panels	Price w/ White foam-board	Price w/ Single-Side fabric	
Basic 3 Table Top		Exclusive of headers	86" x 41"	\$140	\$191	\$323	\$190	\$241	\$373	6300
\$140 base price		3 headers 70 x 30cm*	+13" (h)	\$90	\$111	\$156	\$100	\$121	\$166	6307
Basic 4		Exclusive of headers	58" x 81"	\$215	\$283	\$459	\$335	\$403	\$579	6301
\$215 base price		2 headers 70 x 30cm	+13" (h)	\$60	\$74	\$104	\$65	\$79	\$109	6306
Basic 6		Exclusive of headers	86" x 81"	\$320	\$422	\$686	\$460	\$562	\$826	6302
\$320 base price		3 headers 70 x 30cm	+13" (h)	\$90	\$111	\$156	\$100	\$121	\$166	6307
Basic 8		Exclusive of headers	115" x 81"	\$415	\$551	\$903	—	—	—	—
\$415 base price		4 headers 70 x 30cm	+13" (h)	\$120	\$148	\$208	—	—	—	—
Basic 10		Exclusive of headers	144" x 81"	\$510	\$680	\$1,120	—	—	—	—
\$510 base price		5 headers 70 x 30cm	+13" (h)	\$150	\$185	\$260	—	—	—	—
Add-on basic		Exclusive of header	29" x 81"	\$95	\$129	\$217	—	—	—	—
\$95 base price		1 header 70 x 30cm	+13" (h)	\$33	\$40	\$55	\$33	\$40	\$55	6010

Feet for Backwall

Only for LinkUp model. Incl. stable round base 7½" diameter (5802), U-feet (5822) and H-feet (5821).

	Price / set	Item No.
Basic 4	\$73.00	5851
Basic 6	\$92.00	5852
Basic 8	\$111.00	5853
Basic 10	\$130.00	5854
Add-on basic	\$20.00	5855

*Note: "Basic" is a Mark Bric term for the standard international size 70cm x 100cm (27½" x 39½%), which is used in many of our displays.

*All headers are standard basic size of 70cm x 30cm (27½" x 11½%).

Table, Tower and Cross Units

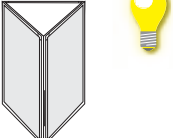
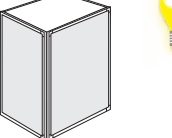
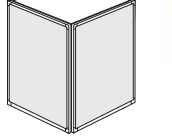
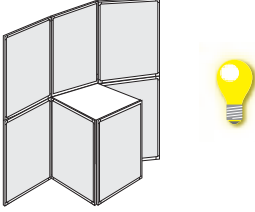
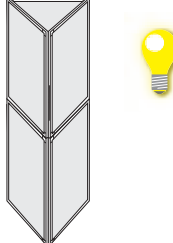
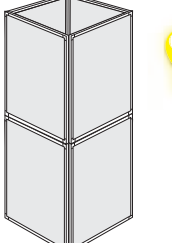
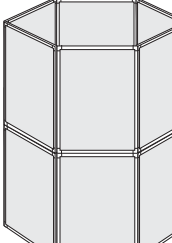
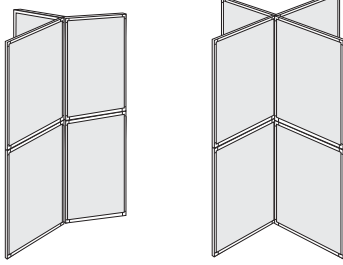
<p>6110 6111 6112</p> <p>Steel Table Top</p>  <p>Triangular Tables \$180 base price</p>	<p>6114 6115 6116 6117 6118 6119</p> <p>Steel Table Top</p>  <p>Rectangular Tables \$200 base price</p>	<p>6120 6121 6123 6124 6125</p> <p>Steel Table Top</p>  <p>Square Tables \$205 base price</p>	<p>6131 6132 6133</p>  <p>Built-In Tables \$220 base price</p>
<p>6200</p>  <p>Triangle Tower \$295 base price</p>	<p>6201</p>  <p>Square Tower \$395 base price</p>	<p>6202</p>  <p>Hexagon Towers \$590 base price</p>	<p>6205 6206</p>  <p>Cross units 3 way - \$295 base price 4 way - \$380 base price</p>

TABLES

Complete unit includes connectors, closed frames with square corners and steel table top (gray, anthracite or white). Other styles are also available — check with Customer Service.

	Item No.	Table Top	Height	w/o Panels	w/ Foam Panels	w/ Fabric Panels
Triangle Tables	6110	29 x 29 x 29"	21"	\$180	\$213	\$273
	6111		29"	\$215	\$275	\$355
	6112 Basic		41"	\$220	\$283	\$403
Rectangle Tables	6114	14 x 29"	21"	\$200	\$235	\$295
	6115		29"	\$230	\$290	\$370
	6116 Basic		41"	\$250	\$320	\$440
	6117	21 x 29"	21"	\$215	\$260	\$325
	6118		29"	\$240	\$300	\$395
	6119 Basic		41"	\$270	\$355	\$485
Square Tables	6120	21 x 21"	21"	\$205	\$245	\$300
	6121		29"	\$205	\$249	\$329
	6123	29 x 29"	21"	\$225	\$269	\$349
	6124		29"	\$265	\$345	\$450
	6125 Basic		41"	\$275	\$359	\$519
Built-In Tables	6131	14 x 29"	41"	\$220	\$270	\$350
	6132	21 x 29"	41"	\$240	\$300	\$395
	6133 Basic	29 x 29"	41"	\$275	\$338	\$458

TOWERS AND CROSSES

Complete unit includes connectors and your choice of closed or open frames with square corners. Approximate outer frame dimensions: 28 x 40". Insert panel size: 27¹/₁₆" x 39³/₈".

	Item No.	Height	w/o Panels	w/ Foam Panels	w/ Fabric Panels
Triangle Towers	6200 Basic	81"	\$295	\$421	\$661
	6210 3-Header Kit	+13" (h)	\$90	\$114	\$156
Square Towers	6201 Basic	81"	\$395	\$563	\$883
	6211 4-Header Kit	+13" (h)	\$120	\$152	\$208
Hexagon Towers	6202 Basic	81"	\$590	\$842	\$1,322
	6212 6-Header Kit	+13" (h)	\$180	\$228	\$312
3-Way Cross	6205 Basic	81"	\$295	\$421	\$823*
	6213 3-Header Kit	+13" (h)	\$95	\$119	\$197*
4-Way Cross	6206 Basic	81"	\$380	\$548	\$1,084*
	6214 4-Header Kit	+13" (h)	\$125	\$157	\$261*



These tables and towers now accept our LightUp backlit displays!

These towers can be built in all sizes — check with Customer Service. Foam panel pricing includes your choice of color.

*Double-sided fabric panels are included in the 3-way and 4-way cross pricing, where both sides are available for viewing.

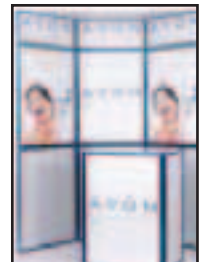
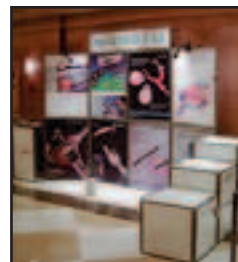
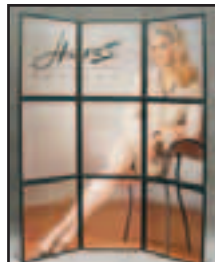

Folding Demonstration Counters

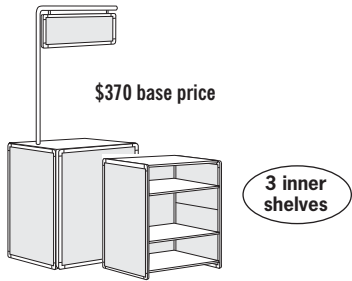

\$370 base price

3 inner shelves

See our new SnapUp-MP counter on page 8

All counters are delivered in cardboard carrying boxes with handle. 1 pc. packing.

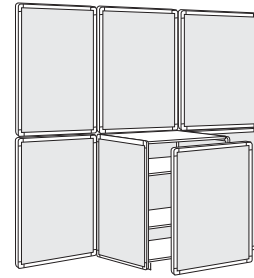

Built-in counters with "Hide-it Frame".

Counters can easily be connected to a backwall. An ideal place to store brochures, samples etc., during a trade show or exhibition and also provides the backwall with extra stability. In this case, the counter is delivered with a "Hide-it Frame" in size 27⁹/₁₆ x 39³/₈, to keep inside of the counter protected from view. The "Hide-it Frame" is connected to the counter with magnetic tape and can easily be taken on and off.

Folding Demonstration Counters
These portable folding counters make excellent stations for presentations, demonstrations and product samplings. Complete unit includes three aluminum shelves and a powder-coated aluminum tabletop. All counters stand 41" high and 28" wide and are available in two depths. They may be fitted with a suspended sign to generate added attention, and also the new Hide-It panel to fully enclose the shelves.

	Approximate Dimensions	Panels of Any Color		Item No.
		w/ Foam Panels	w/ Fabric Panels	
Small Counter	14" x 28" x 41"	\$370.00	\$445.00	6100
Large Counter	20" x 28" x 41"	\$480.00	\$565.00	6101
Hanging Sign Kit	8" x 19 5/8"	\$65.00	\$70.00	6150
Hide-It Panel	28" x 41"	\$80.00	\$120.00	7120
		Price		Item No.
Carrying Case		\$129.00		5000

TABLE TOP DISPLAYS



\$170 base price

Delivered in a cardboard carrying box with handle

FoldUp Table Top Displays

With 3 large, hinged frames and one detachable header, these FoldUp displays are perfect tools for quick presentations in the conference room, the classroom, or on-the-road. Add fabric panels, marker boards, or poster pockets to complete the system.

	Overall Size	Price w/o Panels	Price w/ Foam Panels	Price w/ Poster Pockets	Price w/ Fabric Panels	Item No.
Mini Basic	64w x 38h"	\$170.00	\$197.50	\$203.50	\$273.00	7351
Basic	86w x 54h"	\$213.00	\$271.00	\$281.00	\$418.00	6351

CEILING MOUNTED DISPLAYS

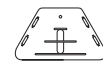
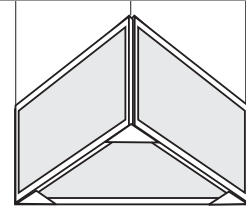

3040

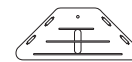

3041

New plastic connectors for joining frames in square or triangular forms. Ideal for suspension. Available in 5 colors: White (51), red (53), blue (54) black (55) and gray metallic (59). Good for all frame sizes.

	Packaging	1 pc.	1 box	Item No.
60° connector	50 pcs.	\$0.50	\$20.00	3040
90° connector	50 pcs	\$0.50	\$20.00	3041

From simple signs to custom exhibits, there's a Flexiframe solution for all your display needs!

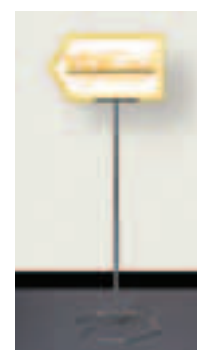
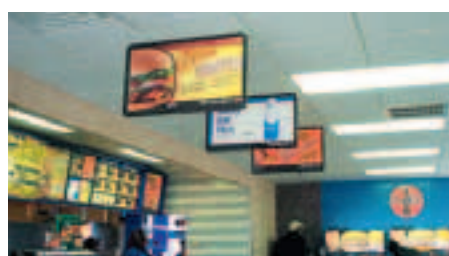

Complete Trade Show Stands - Flexiframe ShowUp™

- Eight ready-to-use exhibition kits from our Flexiframe ShowUp system
- Simple pole-and-panel design enables easy, tool-free set-up and dismantling
 - Each kit comes complete with everything you need
 - Every kit is factory-tested to assure quality
 - Luxus shipping cases included
- Prices shown include foam-board panels – other options are available
- 💡 • Enhance these Exhibition Kits with our LightUp backlit display

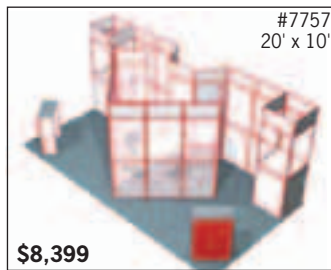
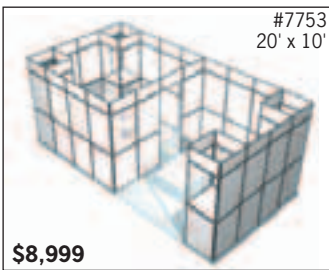
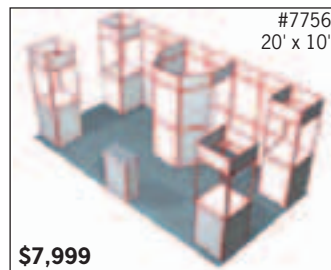
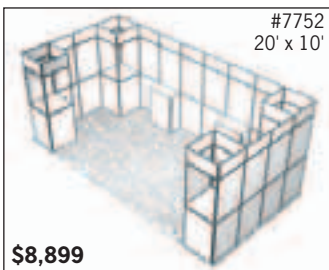
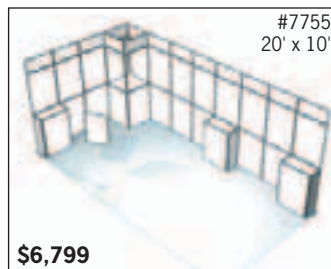
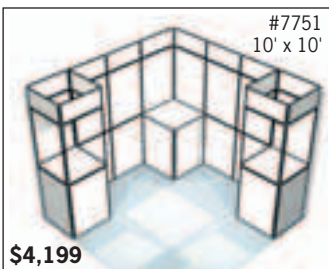
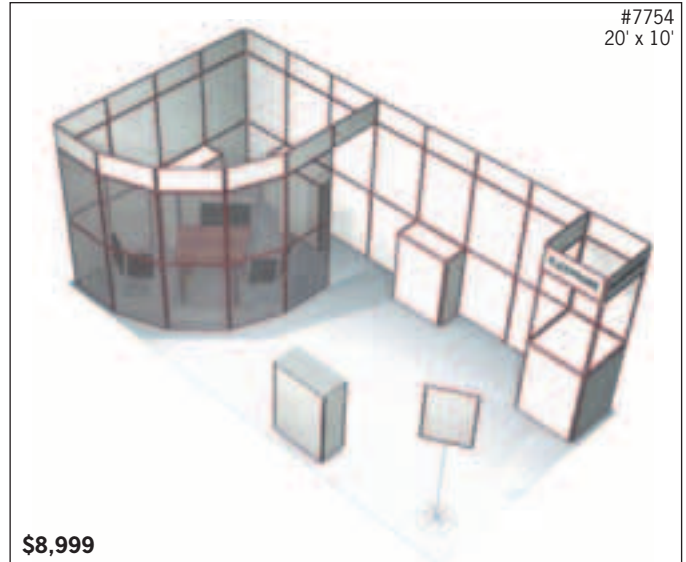
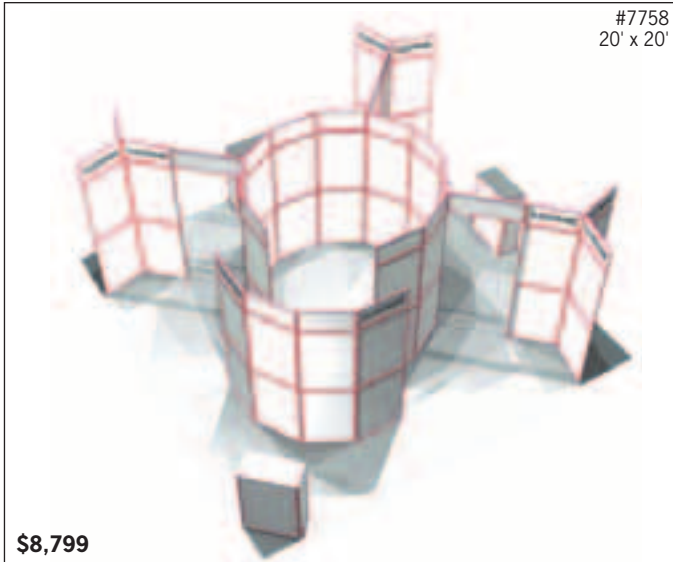

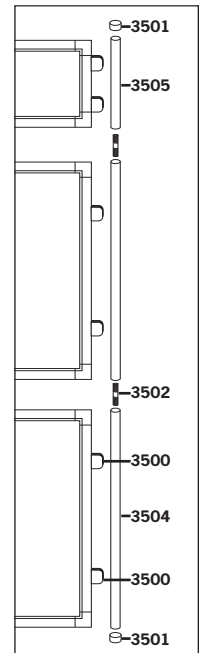
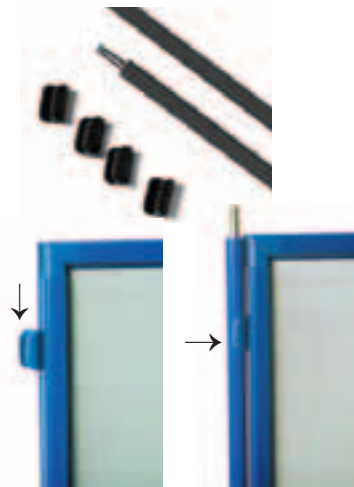

All of these kits use the **Flexiframe ShowUp™** system, with clips and poles to make every connection point identical & eliminate confusion.

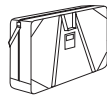

For your convenience and savings, a kit discount of up to 10% has already been applied to all of these list prices.

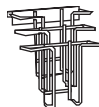
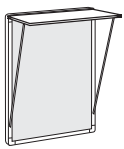
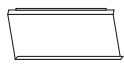
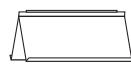
5006  Accessory bag For spotlights and brochure holders (5100) etc. \$69.00	5005  Carrying bags for Mini-backwall For 8 frames 50x70cm (approx. 21"x28") \$129.00	5000 5001 5002  Carrying bags for Basic backwalls Frames 70x100cm (approx. 28x40") Basic 4 \$129.00 Basic 6/8 \$139.00 Basic 10 \$159.00	9060 9061  Carrying bags for other sizes For 4 frames 20" x 24" \$79.00 24" x 36" \$89.00	9065  Luxus case 8-10 frames 70x100 cm High Impact Polyethylene Color: black. Easily portable, 2 wheels. \$375.00
--	--	--	--	---

5100  Brochure pocket White (92), gray (98) or anthracite (91) \$18.00	5101  Triple brochure pocket White (92), gray (98) or anthracite (91) \$45.00	5110  Basic product shelf Approx. 28"x12" White (92), gray (98) or anthracite (91) Max. 10lbs. \$115.00	5102 5103  Mini brochure shelf width 50 cm (19½") White (92), gray (98) or anthracite (91) \$55.00 Basic brochure shelf width 70 cm (27½") White (92), gray (98) or anthracite (91) \$65.00	5105  Basic brochure shelves Double sided, width 70 cm (27½") White (92), gray (98) or anthracite (91) \$145.00	81005  Halogen spotlight Black (93) Two 50W, 120V bulbs incl. (Additional bulbs \$10.00) \$89.00
---	--	--	---	---	--

Insert Panel Material

Size	Poster Pocket	5mm Foam Board		Fabric Single Side	Fabric Double Side	Marker Board	Combo Board
		White	Colors				
8½ x 11"	\$2.00	\$2.00	\$2.25	\$5.75	\$8.50	\$5.30	\$6.90
11 x 14"	\$3.00	\$3.00	\$3.75	\$9.00	\$13.50	\$6.30	\$10.50
11 x 17"	\$3.50	\$3.50	\$4.25	\$11.00	\$16.50	\$7.90	\$13.20
14 x 22"	\$5.50	\$5.00	\$6.50	\$18.00	\$26.00	\$9.00	\$21.00
16 x 20"	\$5.80	\$5.50	\$7.50	\$19.00	\$27.00	\$9.50	\$22.60
18 x 24"	\$8.20	\$6.75	\$8.50	\$25.00	\$36.50	\$12.60	\$29.40
20 x 24"	\$9.00	\$7.00	\$9.50	\$28.00	\$41.00	\$14.20	\$33.10
22 x 28"	\$11.30	\$9.50	\$12.00	\$35.00	\$52.00	\$17.90	\$42.00
24 x 36"	\$15.80	\$13.50	\$17.00	\$50.00	\$73.00	\$25.20	\$58.80
28 x 40"	\$20.50	\$17.00	\$22.00	\$65.00	\$95.00	\$31.50	\$76.70
30 x 40"	\$22.10	\$19.00	\$24.50	\$69.00	\$102.00	\$35.20	\$81.90
BASIC	\$20.00	\$17.00	\$21.00	\$61.00	\$88.00	\$30.50	\$72.50
BASIC HDR	\$8.00	\$7.00	\$8.00	\$22.00	\$34.00	\$9.50	\$26.30
MINI BASIC	\$10.00	\$8.00	\$11.00	\$31.00	\$50.00	\$15.30	\$36.80
MINI HDR	\$3.50	\$3.50	\$4.50	\$10.00	\$17.00	\$5.30	\$12.10
Custom Size/ft²	\$3.00	\$2.75	\$3.25	\$9.75	\$14.00	\$5.00	\$10.00

Wire mesh

Size/Type	Price	Color	Item No.
Basic	\$40.00	White (92)	80104
Hook, 6"	\$3.50	White (92)	80903
Hook, 10"	\$4.50	White (92)	80904

Poster Pocket = Clear Vinyl Cover + 3mm Corplast
Marker Board = Melamine on Hardboard, in white or black
Combo Board = One side fabric, other side white marker board
Grip clips, #4904 (\$0.55/5-pack) hold panels tightly inside the frames. Completely hidden from view, they add extra security and stability to your display.

Lightweight foam centered boards

Blue 23	Dark Gray 24	Light Gray 25
Red 26	Black 27	White 28

Velcro panels

Pacific Blue 02	Blue 03	Dark Gray 04	Light Gray 05
Red 06	Black 07	White 08	Green 09

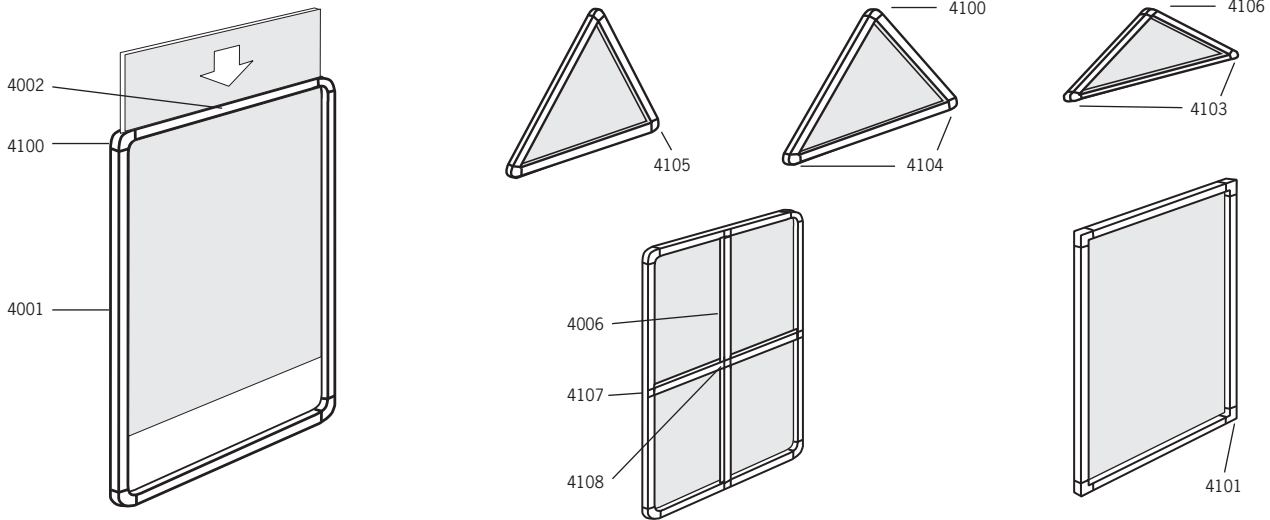

<p>Item No. 4001 Solid profile</p>	<p>Item No. 4002 Split profile</p>	<p>Item No. 4006 Double sided profile</p>	<p>Item No. 4902 Insert panel clip for frames with split profile</p>	<p>Item No. 4904 Panel grip</p>
<p>Item No. 4100 2-way corner 90°</p>	<p>Item No. 4103 2-way corner 30°</p>	<p>Item No. 4105 2-way corner 60°</p>	<p>Item No. 4107 3-way corner 90°</p>	<p>Item No. 5897 Profile extender</p>
<p>Item No. 4101 2-way corner 90°</p>	<p>Item No. 4104 2-way corner 45°</p>	<p>Item No. 4106 2-way corner 120°</p>	<p>Item No. 4108 4-way corner 90°</p>	<p>Item No. 80900 Profile cutter tool</p>
				<p>Item No. 3204 I-support, 3-way corner 3-way corners (4107) should always be used with 3204</p>

Profiles - standard colors

Length of profile 7½ feet (90"). Each box contains profiles in the same color.

	Item No.	1 pc.	1 box	Packing
Solid profile	4001	\$23.00	\$350.00	20 pcs.
Split profile	4002	\$23.00	\$350.00	20 pcs.
Double profile	4006	\$23.00	\$265.00	15 pcs.

For less than full-length profiles, price is \$0.30 per inch. To mix colors in one box, add \$15.00 to box price

Extras	Item No.	1 pc.	1 box	Packing
Panel retaining clip	4902	\$0.35	\$25.00	100 pcs.
Profile extender	5897	\$2.50	\$59.00	25 pcs.
Profile cutting tool	80900	\$75.00	n/a	1 pc.
I-support, 3-way corner	3204	\$1.50	\$142.00	100 pcs.

Cutting of profiles

To cut profile to fit desired rectangle insert panel sizes, subtract 1" from insert panel dimensions and cut profile to those lengths.



Basic Corners - standard colors

Each box contains corners in one color. All basic corners now include corner locks.

	Type	Item No.	1 pc.	1 box	Packing
2-way corner - round	90°	4100-L	\$1.05	\$325.00	400 pcs.
2-way corner - square	90°	4101-L	\$1.05	\$325.00	400 pcs.

To mix colors in one box, add \$15.00 to box price.

Special Corners

Except for 4107-L, these corners do not include corner locks.

	Type	Item No.	1 pc.	1 box	Packing
2-way corner	30°	4103	\$2.25	\$680.00	400 pcs.
2-way corner	45°	4104	\$2.25	\$680.00	400 pcs.
2-way corner	60°	4105	\$2.25	\$680.00	400 pcs.
2-way corner	120°	4106	\$2.25	\$680.00	400 pcs.
3-way corner	90°	4107	\$2.25	\$430.00	250 pcs.
3-way corner locked	90°	4107-L	\$2.75	\$530.00	250 pcs.
4-way corner	90°	4108	\$2.50	\$295.00	150 pcs.

Grip Clips

The grip clips hold panels tightly inside the frames. Completely hidden from view, they add extra security and stability to your display. Use 4 pcs./panel.

	Item No.	5 pack	1 box	Packing
Grip clip, use 4 pcs./panel	4904	\$0.55	\$85.00	1000 pcs.

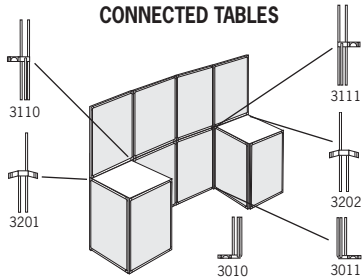
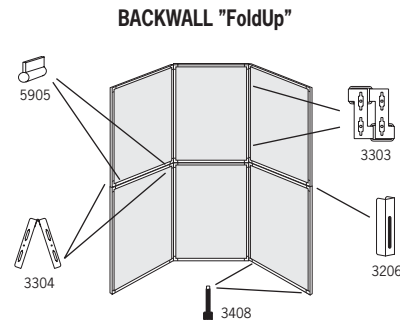
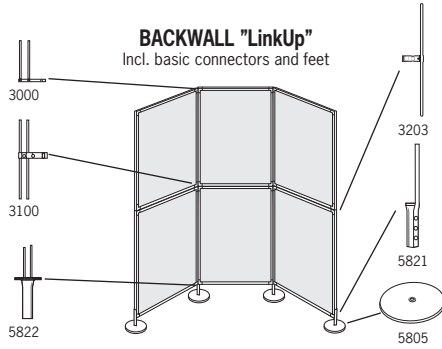

CONNECTED TABLES

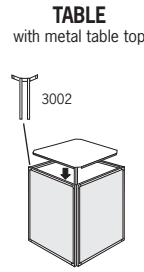

TABLE
with metal table top

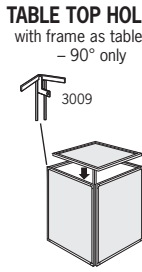

TABLE TOP HOLDER
with frame as table top
– 90° only

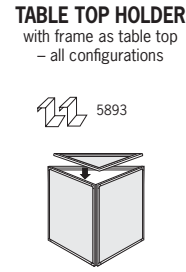
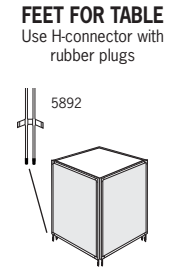
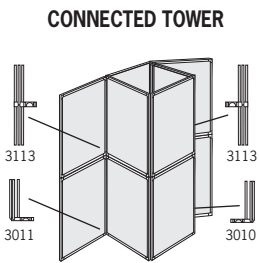

TABLE TOP HOLDER
with frame as table top
– all configurations



FEET FOR TABLE
Use H-connector with rubber plugs



CONNECTED TOWER

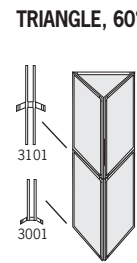

TRIANGLE, 60°

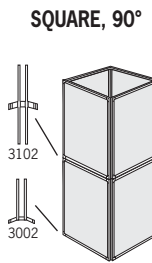

SQUARE, 90°

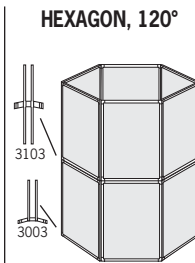

HEXAGON, 120°

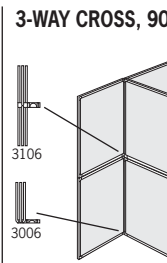

3-WAY CROSS, 90°

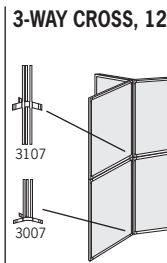

3-WAY CROSS, 120°

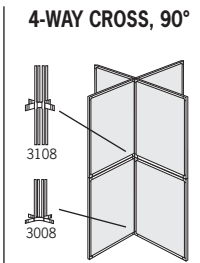

4-WAY CROSS, 90°

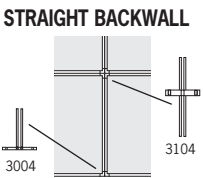

STRAIGHT BACKWALL

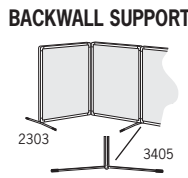

BACKWALL SUPPORT

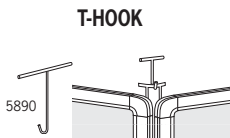

T-HOOK

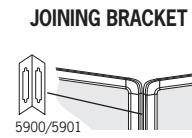

JOINING BRACKET

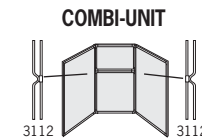

COMBI-UNIT

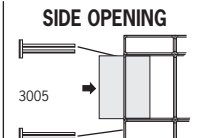

SIDE OPENING

Components for FoldUp	Item No.	1 pc.	1 box	Packing
Double acting hinge, chrome or black	3303	\$6.00	\$540.00	100 pcs.
Vertical hinge, chrome or black	3304	\$27.00	\$245.00	10 pair
Top tab	5905	\$2.50	\$225.00	100 pcs.
Side locking bar, chrome or black	3206	\$8.00	\$72.00	10 pcs.
Foot screw	3408	\$2.50	\$225.00	100 pcs.
Backwall supports	Item No.	1 pc.	1 box	Packing
Stabilizing foot (outer)	2303	\$18.00	\$80.00	5 pairs
Stabilizing foot (inner)	3405	\$10.75	\$95.00	10 pcs.
Feet	Item No.	1 pc.	1 box	Packing
Straight base	5800	\$8.25	\$370.00	50 pcs.
Round base, chrome, 6" dia..	5801	\$8.25	\$190.00	25 pcs.
Round base, gray, 9.5" dia..	5805	\$17.50	\$160.00	10 pcs.
Round base, gray, 11.5" dia..	5803	\$34.50	\$155.00	5 pcs.
Heg (outer)	5820	\$9.00	\$405.00	50 pcs.
Heg (outer), extra support	5821	\$16.50	\$150.00	10 pcs.
U-leg (inner)	5822	\$9.00	\$405.00	50 pcs.
U-leg, triangle 60°	5823	\$14.00	\$630.00	50 pcs.
U-leg, square 90°	5824	\$14.00	\$630.00	50 pcs.
U-leg, hexagon 120°	5825	\$14.00	\$630.00	50 pcs.
U-leg, 3-way (left)	5826	\$14.50	\$650.00	50 pcs.
U-leg, 3-way (right)	5827	\$14.50	\$650.00	50 pcs.
U-leg, 4-way	5828	\$17.75	\$795.00	50 pcs.

Each base should be combined together with a leg.

Metal table tops (white, gray or anthracite)	Item No.	1pc.	Packing	
Triangle, 9" x 9" x 9"	5209	\$17.00	1 pc.	
Triangle, 12" x 12" x 12"	5208	\$22.00	1 pc.	
Triangle, 21" x 21" x 21"	5207	\$52.00	1 pc.	
Triangle, 29" x 29" x 29"	5206	\$67.00	1 pc.	
Triangle, 29" x 29" x 40"	5214	\$135.00	1 pc.	
Square, 10" x 10"	5202	\$22.00	1 pc.	
Square, 21" x 21"	5201	\$52.00	1 pc.	
Square, 29" x 29"	5200	\$70.00	1 pc.	
Rectangle, 21" x 29"	5203	\$65.00	1 pc.	
Rectangle, 14" x 29"	5204	\$56.00	1 pc.	
Hexagon, 6 sides x 29"	5205	\$115.00	1 pc.	
Table top holders (for frame tops)	Item No.	1pc.	1 box	Packing
U-connector with tabletop holder	3009	\$12.00	\$1080.00	100 pcs.
H-connector with tabletop holder	3109	\$14.75	\$1330.00	100 pcs.
Tabletop holder, stainless steel	5893	\$1.65	\$150.00	100 pcs.
Tabletop holder, in frame color	5893	\$2.50	\$225.00	100 pcs.
Tabletop holders should be used when a frame (with panel) is used as a table top, instead of a metal table top. With table top holders, any size of table top can be fitted.				
Extras	Item No.	1pc.	1 box	Packing
T-hook for disassembly	5890	\$3.75	\$340.00	100 pcs.
Joining bracket, 90°, chrome or black	5900	\$3.00	\$135.00	50 pcs.
Joining bracket, 120°, chrome or black	5901	\$3.00	\$135.00	50 pcs.
Rubber tips for connectors	5892	\$0.20	\$18.00	100 pcs.

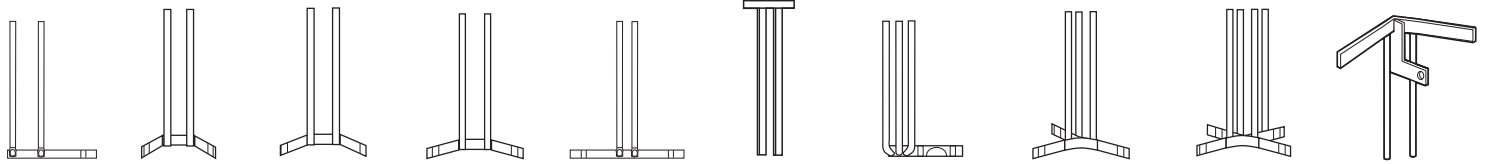

3000 U-connector, standard
3001 U-connector, triangle 60°
3002 U-connector, square 90°
3003 U-connector, hexagon 120°
3004 U-connector, 180°
3005 U-connector, side insert
3006 U-connector, 3-way cross 90°
3007 U-connector, 3-way cross 120°
3008 U-connector, 4-way cross 90°
3009 U-connector, with table top holder

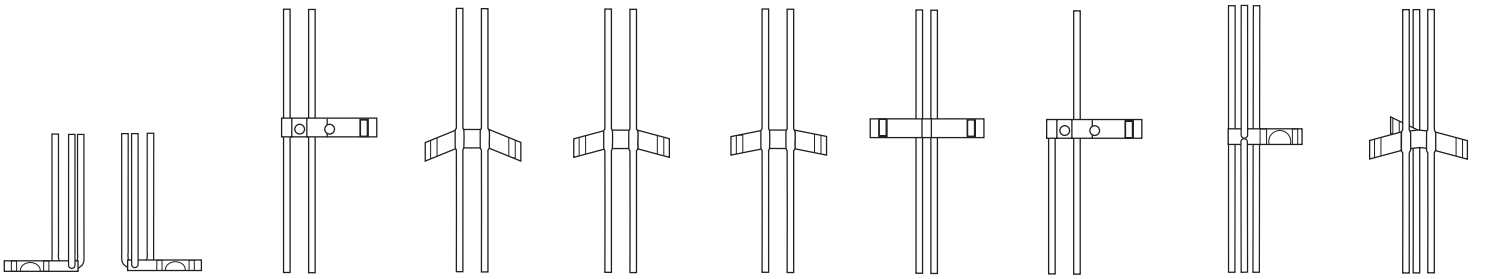

3100 H-connector, standard
3101 H-connector, triangle 60°
3102 H-connector, square 90°
3103 H-connector, hexagon 120°
3104 H-connector, straight 180°
3105 H-connector, top frame connector
3106 H-connector, 3-way cross 90°
3107 H-connector, 3-way cross 120°

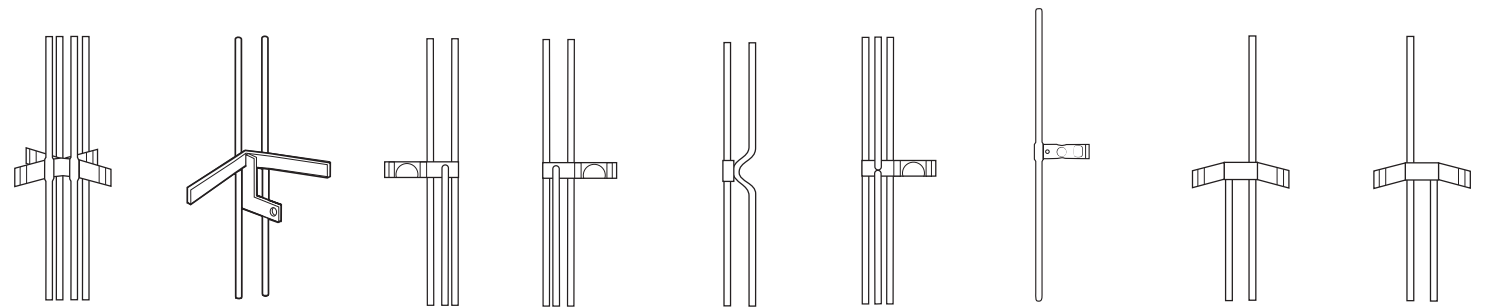

3108 H-connector, 4-way cross 90°
3109 H-connector, with table top holder
3110 H-connector, 3-way (left)
3111 H-connector, 3-way (right)
3112 H-connector, combi-unit
3113 H-connector, 3-way
3200/3203 I-connector, for backwalls
3201 I-connector, 2-way 90° (left)
3202 I-connector, 2-way 90° (right)

All connectors galvanized, all feet chrome plated and all table tops powder-coated.

Basic connectors (LinkUp)				Other connectors (LinkUp)					
Item No.	1pc.	1 box	Packing	Item No.	1pc.	1 box	Packing		
U-connector	3000	\$3.20	\$290.00	100 pcs.	H-connector, triangle 60°	3101	\$7.10	\$650.00	100 pcs.
H-connector	3100	\$5.70	\$510.00	100 pcs.	H-connector, square 90°	3102	\$7.10	\$650.00	100 pcs.
I-connector	3200	\$4.10	\$370.00	100 pcs.	H-connector, hexagon 120°	3103	\$7.10	\$650.00	100 pcs.
I-connector, long for backwall	3203	\$4.10	\$370.00	100 pcs.	H-connector, straight 180°	3104	\$7.10	\$650.00	100 pcs.
Other connectors (LinkUp)				Other connectors (LinkUp)					
Item No.	1pc.	1 box	Packing	Item No.	1pc.	1 box	Packing		
U-connector, triangle 60°	3001	\$5.10	\$460.00	100 pcs.	H-connector, top frame connector	3105	\$6.30	\$570.00	100 pcs.
U-connector, square 90°	3002	\$5.10	\$460.00	100 pcs.	H-connector, 3-way cross 90°	3106	\$14.20	\$1,280.00	100 pcs.
U-connector, hexagon 120°	3003	\$5.10	\$460.00	100 pcs.	H-connector, 3-way cross 120°	3107	\$14.20	\$1,280.00	100 pcs.
U-connector, straight 180°	3004	\$5.10	\$460.00	100 pcs.	H-connector, 4-way cross 90°	3108	\$15.60	\$360.00	25 pcs
U-connector, 180°, side insert	3005	\$5.10	\$460.00	100 pcs.	H-connector, for table top	3109	\$15.50	\$1,397.00	100 pcs.
U-connector, 3-way cross 90°	3006	\$5.80	\$520.00	100 pcs.	H-connector, 3-way (left) 90°	3110	\$9.40	\$840.00	100 pcs.
U-connector, 3-way cross 120°	3007	\$11.30	\$1,020.00	100 pcs.	H-connector, 3-way (right) 90°	3111	\$9.40	\$840.00	100 pcs.
U-connector, 4-way cross 90°	3008	\$12.40	\$1,110.00	100 pcs.	H-connector, combi-unit	3112	\$10.50	\$950.00	100 pcs.
U-connector, for table top	3009	\$12.60	\$1,140.00	100 pcs.	H-connector, 3-way 90°	3113	\$14.20	\$1,280.00	100 pcs.
U-connector, 3-way (left) 90°	3010	\$5.80	\$520.00	100 pcs.	I-connector, 2-way (left) 90°	3201	\$7.40	\$670.00	100 pcs.
U-connector, 3-way (right) 90°	3011	\$5.80	\$520.00	100 pcs.	I-connector, 2-way (right) 90°	3202	\$7.40	\$670.00	100 pcs.
					I-connector, header	5895	\$15.00	\$140.00	10 pairs

Frames and panel sizes

Overall size = Panel size plus 1 1/8"
 Visible panel size = Panel size less 3/4"
 Cutting size of profile = Panel size less 1"
 For example:

Panel size: 22" x 28"
 Overall size: 23 1/8" x 29 1/8"
 Visible panel size: 21 1/4" x 27 1/4"
 Cutting size of profile: 21" x 27"

Materials & Properties

The frame profiles are produced in durable PVC plastic.
 The corner pieces are produced in polypropylene-plastic.
 We recommend interior use of the frames.
 Temperature range, 0° to 120°F (-20° to 50°C)

Materials & Properties (cont.)

All colors have improved UV stabilizers, but to minimize color changes in outdoor applications, we recommend darker frame colors, for example black or metallic gray.

Flammability

UL 94 V-0 (low)

Flexiframe Tables

Tabletops are produced in powder-coated steel. We recommend that table top loading should not exceed 50 lbs. When building table displays, the frame insert panels must be accurately cut to size and squareness to ensure maximum strength and stability of the table.

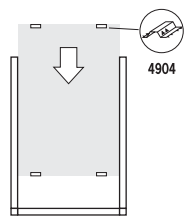

Helpful Hint !
 Always put "grip clips", **item 4904**, on insert panels in closed frames of backwalls, tables, towers and other display and exhibition kits. The panel "grip clips" hold panels tightly inside the frames and add extra security and stability to your display. Use 4 pcs./panel: 2 pcs. on the bottom side of the panel and two pcs. at the top.

BannerUp Production Guidelines

BannerUp Plus	PLUS	3ft.	40 in.	4ft.	5ft.	BannerUp Original
Full height, 3 pole sections	Banner width	34 5/8"	39 3/8"	47 1/4"	59"	Full height, 3 pole sections
Visible banner length: 81 in	Weight	11 lbs.	13.2 lbs.	15.4 lbs.	17.6 lbs.	Visible banner length: 77 in
With extension pole, item 89255 = 88 1/2 in	Cassette dimensions	5 1/2d x 4 3/8h x 35w	5 1/2d x 4 3/8h x 39 3/4w	5 1/2d x 4 3/8h x 47 5/8w	5 1/2d x 4 3/8h x 59 1/2w	With extension pole, item 89255 = 84 1/2 in
Total banner length: 94 1/2 in	Standard height					Total banner length: 90 1/2 in
With extension pole, item 89255 = 102 in	Visible print length	81"	81"	81"	81"	With extension pole, item 89255 = 98 in
	Full height	83"	83"	83"	83"	
	Optional height with extension pole/s, 89255					
	Visible print length	88 1/2"	88 1/2"	88 1/2"	88 1/2"	
	Full height	90 1/2"	90 1/2"	90 1/2"	90 1/2"	
	ORIGINAL	3ft.	40 in.	4ft.	5ft.	
	Banner width	34 5/8"	39 3/8"	47 1/4"	59"	
	Weight	13.2 lbs.	15.4 lbs.	19.8 lbs.	24.2 lbs.	
	Cassette dimensions	4 1/2d x 4h x 35w	4 1/2d x 4h x 39 3/4w	4 1/2d x 4h x 47 5/8w	4 1/2d x 4h x 59 1/2w	
	Standard height					
	Visible print length	77"	77"	77"	77"	
	Full height	81 1/2"	81 1/2"	81 1/2"	81 1/2"	
	Optional height with extension pole/s, 89255					
	Visible print height	84 1/2"	84 1/2"	84 1/2"	84 1/2"	
	Full height	89"	89"	89"	89"	
Bleed Area: 1 1/2 in						Bleed Area: 1 1/2 in
Extra banner material (unprinted): 12 in						Extra banner material (unprinted): 12 in

The banner material can be vinyl, fabric, double sided laminated paper etc. The material should be supple enough to easily roll around the roller. Recommended maximum thickness of material: 0.018 in (18 mil)

SnapUp Panel Production Guidelines

Graphic Panel Width A

B Graphic Panel Height	A		C Total Panel Height
	Backwall Style	Panels required	
10 ft. Curved		4 center 2 end	31 1/2"
		3 center 2 end	
8 ft. Curved		3 center 2 end	29 1/2"
		2 center 2 end	
7 ft. Straight		2 center 2 end	27 1/2"
		2 center	
6 ft. Curved		2 center 2 end	25 1/2"
		2 center	
Tower		3 center	23"

The size of each panel for the different SnapUp models is as follows:

	Graphic Panel Widths (A)			Graphic Panel Heights (B)	Total Panel Heights (C)
	Center	End	Rear*		
Snap-Up MP Backwall	27 9/16"	19 1 1/16"	31 5/16"	85 5/8"	88 3/4"
SnapUp MP Tower - Standard	27 1/4"			84 7/16"	87 5/8"
SnapUp MP Tower Extra Tall	27 1/4"			113 3/16"	116 3/8"
SnapUp MP Case	80"				31 1/2"
SnapUp MP Counter	12 15/16"	18 1/8"		39 1/2"	
SnapUp-Original Curved Backwall	27 3/8"	23"	32 1/2"	89 1/2"	91 1/2"
SnapUp-Original Straight Backwall	29 13/16"	29 13/16"	29 13/16"	89 1/2"	91 1/2"
SnapUp-Original Case/Counter	68"				31 3/4"
SnapUp-Original Curved Tabletop	27 3/8"	23"	32 1/2"	59 1/2"	61 1/2"

There are many materials and a variety of techniques for producing the graphic panels, including 3-ply construction (lamine + print media + opaque backing) and 2-ply construction (lamine + printable opaque media). Regardless of the technique used, total thickness ranges are recommended at:

Center panels: .020" to .030" End panels: .015" to .020"

Note: Backlit panels for use with the Tower Light Kit require Duratrans material or equivalent.

*Rear panels used only on double sided models.

Frames (Flexiframe)

There are 14 standard colors to choose from, enabling you to match your graphic panel and/or your company identity.

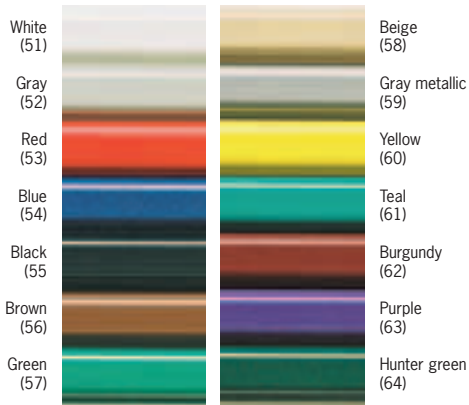

Velcro panels

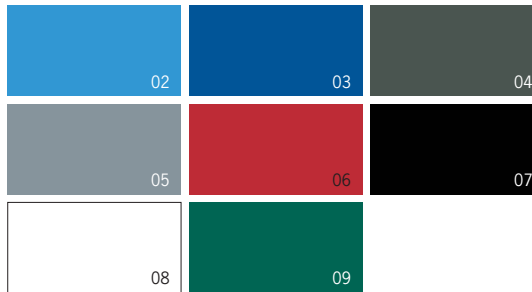

Lightweight foam centered boards

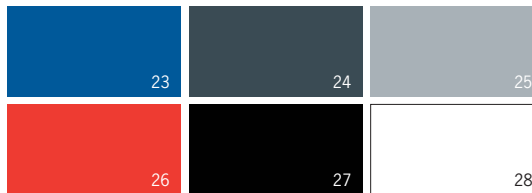

Metal stands

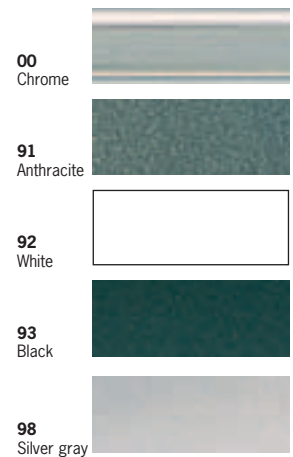

Marketing Brochures

Sales Tools

For Mark Bric distributors/dealers only

Frames & Banner Rails



Modular Displays & Exhibits



Literature Stands



PopUp Displays



Sign & Poster Stands



Backlit Displays



Banner Stands



Use these product-line brochures to generate new business!
Available for all dealers at no charge, with space for your corporate identity label.



Flexiframe Brochure-Stand
 "Charlie Table Stand"
 Ideal for tables and counters.
 Swivel-base. **Item 9861**



Flexiframe Demo-Box with handle
 "Indispensable for all Flexiframe dealers"!
 Incl. frames in 8½"x11", basic connectors, color samples. **Item 9850**



CD – Flexiframe Reference Photo
 Incl. 450 reference photos. **Item 9741**



Demo-Graphics
 SnapUp, MP 4x3, "Man in Water", **item 9803**
 SnapUp, Tower, "Set-up", **item 9816**



Flexiframe Demo-Stand on wheels
 "Charlie Floor Stand"
 Ideal in show-rooms and at exhibitions.
 Including posters, sample frames, basic connectors, color samples, brochure pockets etc. **Item 9860**



EcDesign Software
 PC based 3-D design program provides full virtual reality capabilities. **Item 9742**



BU, 3 ft., "Thumbs Up", **item 9805**
 BU, 40", "V-Sign", **item 9806**
 BU, 3x3 ft. "Full hand", **item 9807**
 BU Lite "OK", **item 9814**



BU, 3 ft., "Tiger", **item 9880**
 BU, 3 ft., "Clown", **item 9881**

All Demo-Graphics available on CD for local production

Please contact us for more information and prices.

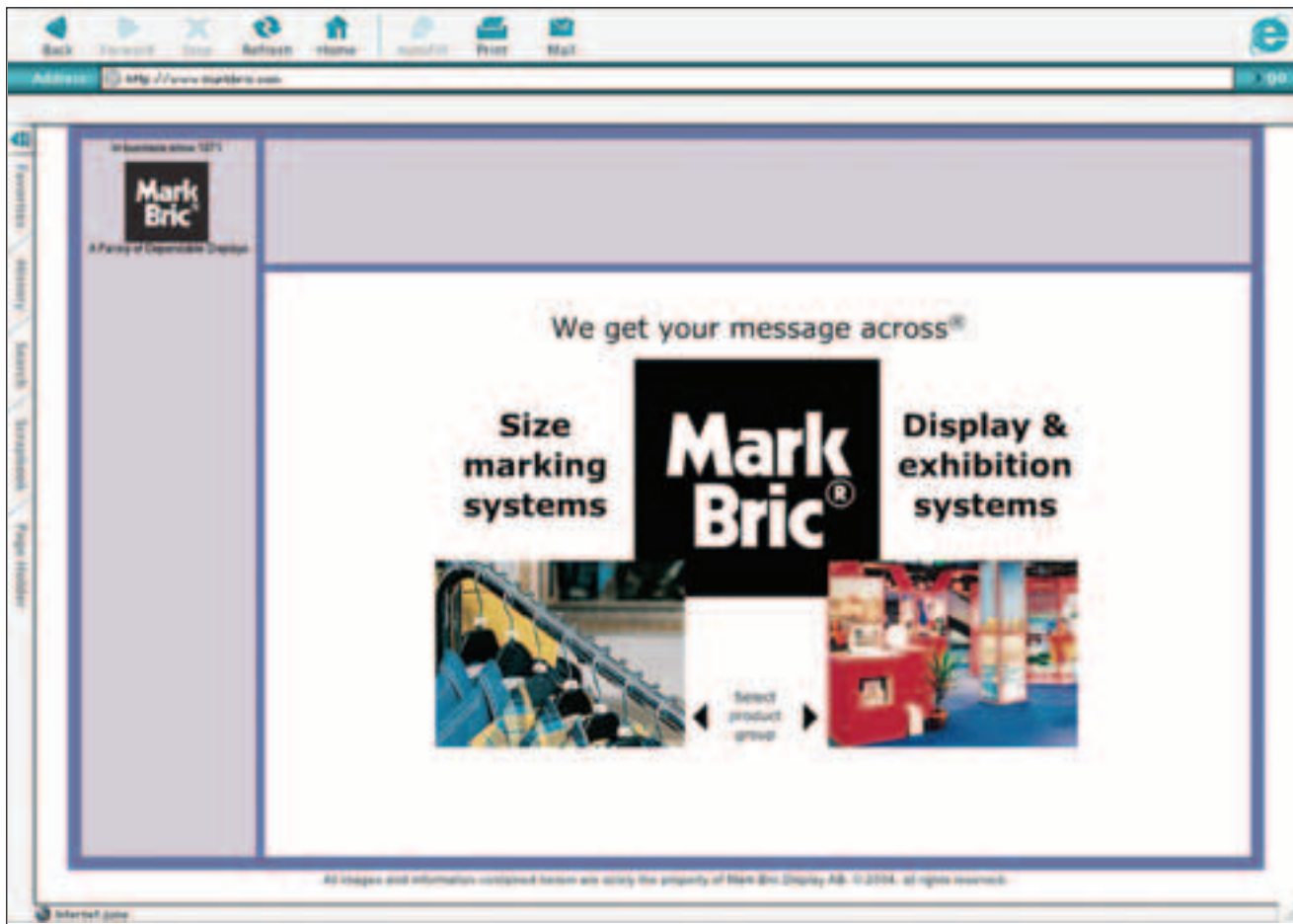

Why Choose Mark Bric?

Our goal is to perform our job so well, so consistently, that you'll never want to trust your business to anyone else. And what is our job?

Our job is to take care of all of the details associated with display hardware so that you don't have to. We understand that time is your most precious resource, and by making our work as nearly perfect as possible, we will keep your time investment to a bare minimum.

Our commitments to you:

- We will always treat you and your business with the utmost respect.
- We will always address your needs with a friendly, world-class customer service staff.
- We will constantly seek to bring dependable, innovative products to market.
- Our products will always represent a high value – always worthy of your hard-earned dollars.
- We will always try to get it right the first time.
- Whenever there is a problem, we'll fix it – **period!**

We invite you to take us up on these commitments and to let us know if we fall short. We believe that if we consistently deliver on these promises, we will have played at least a small role in simplifying your business and saving more of your time and energy for the really important things—your family, your volunteer activities, your hobbies...your life.

Regards,

Larry Ragland
President, Mark Bric Display Corp.

Ed Marquez
Vice President, Mark Bric Display Corp.



A Family of Dependable Displays

Exciting new products that can expand your business!



Mark Bric MultiMaster™

Our newest banner stand gives you lots of ways to make sure that your banners get noticed!



Mark Bric SnapUp-MP® Counter

This newest member of the SnapUp family will be a great addition to your next tradeshow & for any portable presentation opportunity. Classy wooden top & shelves add a professional finishing touch.

Mark Bric EcDesign 3-D Design Software

Free Trial Version Now Available!

This unique new design software (for PC platforms) will quickly become your most valuable sales partner. Working from a large menu of Mark Bric products, you can quickly select the products you need, add your own graphics to the images, arrange the products on a 2-D grid, then zoom into full 3-D viewing and virtual-reality tours. Generate quotations, print and save jpg images, even email 3-D files that offer all of the virtual-reality features. The new version has been updated with more products & features to become an even stronger support tool.



Use your own PC

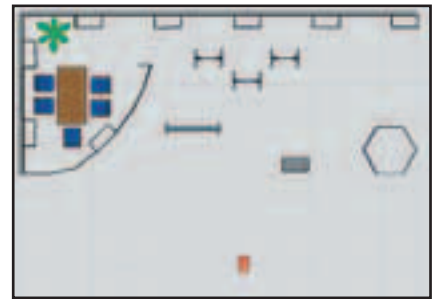

Build on a 2-D grid



Full 3-D viewing



Virtual-reality capability



Mark Bric StandUp™ Plus

Check out the new Mark Bric StandUp Plus! Rugged all-steel construction, 5 large shelves, a double-locking mechanism for secure set-up, and two color choices make this portable literature stand a sure winner.

Mark Bric BannerRail™ Aluminum Slide-in



This new BannerRail product, already used successfully in a major national P-O-P project, is now available for your presentation needs. Specially designed for thicker, stiffer materials such as PVC and poster board.



We Get Your Message Across®

Protected by International Patents and US Patent Nos. 4,977,696, Des. 359,443, and Des. 359,444. Eur. Patent No. 1285421
© Mark Bric Display Corp. 2005. All rights reserved.

Mark Bric Display Corp.

Telephone: 800-742-6275 Fax: 800-565-9506
www.markbric.com

Standard Terms

Mark Bric Display Corporation
4740 Chudoba Parkway • Prince George, VA 23875

Freight: Normally shipped FedEx Saver; all prices include free ground freight on orders of \$100 or more.
Delivery: Most orders shipped within three (3) working days.
Credit: All major credit cards accepted. Net 30 terms available, subject to approval, for repeat customers.
Warranty>Returns: All products guaranteed against defects in quality and workmanship for one year of normal use, with replacement or repair at Mark Bric's discretion. All returns require written approval and may invoke re-stocking fees. Custom products are non-returnable.
Prices: Prices shown are retail prices. We reserve the right to change prices without notice.